

CALLISTO 7FT AMERICAN POOL TABLE



**MIGHTYMAST
LEISURE**

ASSEMBLY INSTRUCTIONS

**Please keep for future reference
Adult Assembly Required**

(1115)

ASSEMBLY INSTRUCTIONS









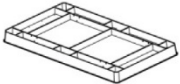

Please keep these instructions for future reference. Adult assembly required.

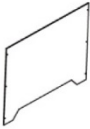
This table is not a toy & is intended for use by or under the supervision of adults.

Please do not sit, climb or lean on the table. Do not drag the table when moving it in order to avoid damaging the legs. The table is intended for indoor use only.

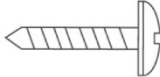
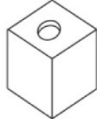
Use just furniture spray polish to clean the exterior laminate surfaces.

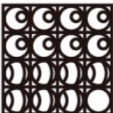
PARTS IDENTIFIER

<p>1</p>  <p>Main Cabinet 1 Piece</p>	<p>2</p>  <p>Leg 4 Pieces</p>	<p>3</p>  <p>Leg Panel 4 Pieces</p>	<p>4</p>  <p>Allen key 1 Piece</p>	<p>5</p>  <p>Leg Leveler 4 Pieces</p>
<p>6</p>  <p>50MM Bolt 12 Pieces</p>	<p>7</p>  <p>19MM Washer 12 Pieces</p>	<p>8</p>  <p>20MM Screw 24 Pieces</p>	<p>9</p>  <p>Chalk 2 Pieces</p>	<p>10</p>  <p>Brush 1 Piece</p>
<p>11</p>  <p>Cue Stick 2 Pieces</p>	<p>12</p>  <p>Billiard Ball 1 Set</p>	<p>13</p>  <p>Triangle 1 Piece</p>		

1. Find a clean & level place to begin the assembly of your CALLISTO Pool Table. The table will be assembled upside down & then turned over onto its legs once the assembly is completed – this is heavy & turning it over will require two strong adults.

2. Remove all parts from the box & verify that you have all the pieces that are listed on the 'Parts Identifier'. Carefully cut or tear the four corners of the box so that the bottom can be used as your work surface. Save all packing materials until the parts have been inspected & the table is assembled.

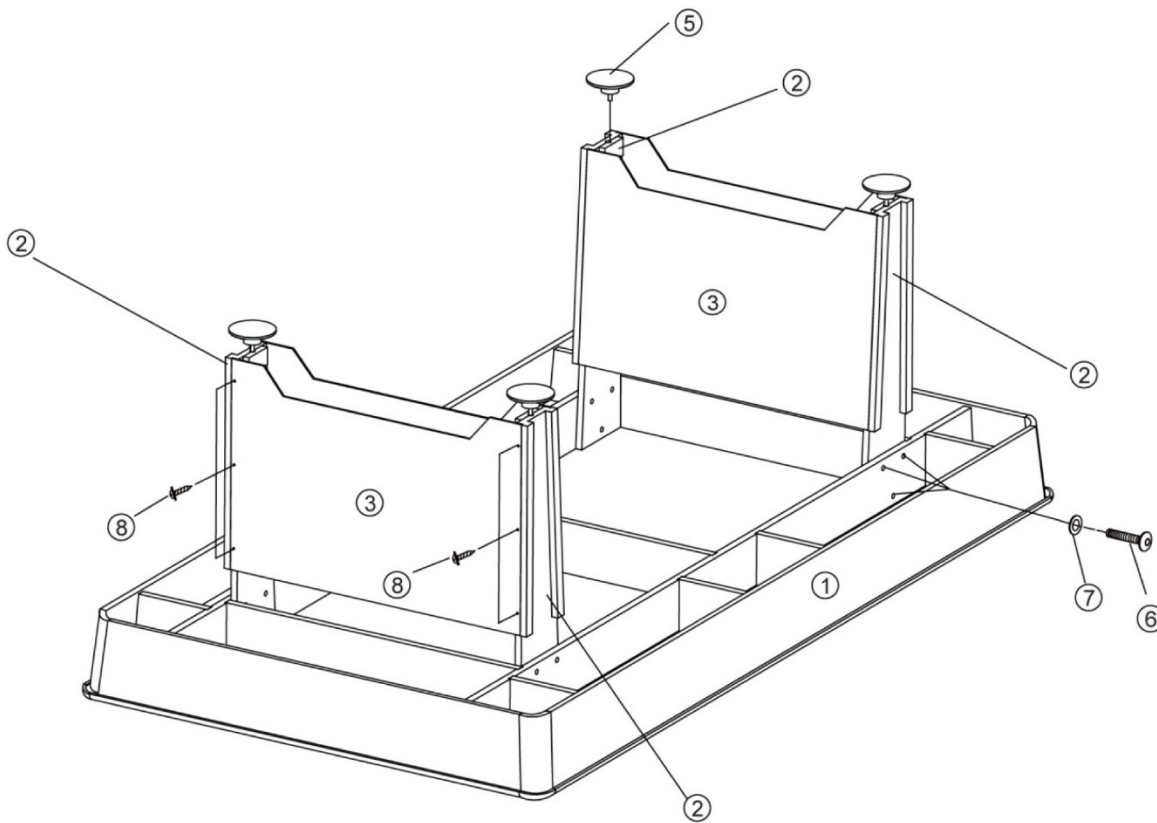

3. Attach the legs (#2) to the main cabinet (#1) using 3 bolts (#6) & 3 washers (#7) per leg with #4 allen key.
4. Attach the leg panels #3 to the legs using 6 screws (#8) per panel.
5. Screw the leg levellers (#5) into the legs.
6. Lift the table assembly from the floor with at least two strong adults, turn it over & set it down on its legs.

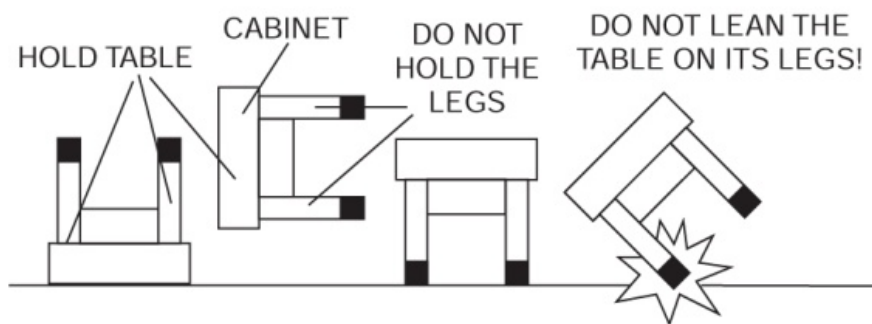

You are now ready to play!



For sales & service contact:
 Mightymast Leisure Ltd, 58 Bentwaters Park, Rendlesham, Woodbridge, Suffolk. IP12 2TW UK
 Tel: +44 (0)1394-460896
 Fax: +44 (0)1394-461326
 www.mightymast.com
 info@mightymast.com